

EXPERIENCE MOBILITY

LIGHTWEIGHT TECHNOLOGIES.

MULTIFUNCTIONAL. DURABLE. EFFICIENT.



SYSTEM PARTNER. PROBLEM SOLVER. PIONEER.

SHAPING THE FUTURE. WITH ELRINGKLINGER.

For us, system expertise means being a pioneer, creating freedom and reaching goals faster. With our portfolio, we offer groundbreaking solutions for all vehicles, whether traditional, hybrid or pure electric.

Proximity to the customer, developing visions, overcoming challenges and driving forward innovations: Those are our key strengths, that's what has made us what we are today.

YEARS LEADING THE WAY



140

Nothing can replace experience combined with innovative spirit. ElringKlinger has plenty of both. In 1879, Paul Lechler founded a trading company for technical products, which would later become ElringKlinger AG. Today, we are a global player offering future-proof solutions for all drive types in all product areas. We also demonstrate our strengths in other industrial sectors. Our customers benefit from ElringKlinger's combined materials, engineering, and manufacturing expertise. Thinking ahead, developing solutions, being the first to break new ground, taking responsibility. This is what sets us apart – and has done so for more than 140 years.

4

KEY STRATEGIC
FIELDS

Alternative drive technologies, lightweight solutions, new forms of mobility, sustainability and climate protection: The transformation process in the automotive industry is in full swing. The agenda for the future is clear. We are also working every day to play our part and push the limits of what is possible. We are focusing on four strategic fields: e-mobility, lightweight technologies for all drive types, traditional mobility and non-automotive. Together with our customers, we are already finding answers to the questions of the future. And successfully driving forward innovations.

10,000

EMPLOYEES AS PARTNERS

For our customers, we are a strong and reliable development partner and series supplier with unique expertise. We are a pioneer and companion. From the idea to the finished product. Whether electro-mobility, lightweight solutions, sealing and shielding technology, tooling technology or engineering services – ElringKlinger impresses with the highest quality, reliability and performance. Around 10,000 employees are committed to achieving this at 44 sites worldwide.

HIGH-PERFORMANCE PLASTIC PARTS FOR PASSENGER AND COMMERCIAL VEHICLES

STRONG PARTS, LIGHTWEIGHT DESIGN.

Improved safety, more comfort, better handling. Modern vehicles have a lot to offer. Intelligent lightweight design is necessary to ensure that these extra features and performance options do not drive up vehicle weight.

**FUNCTIONAL INTEGRATION:
QUALITY AND SYSTEMS COMPETENCE COMBINED**

For ElringKlinger, intelligent lightweight design means more than simply reducing weight. We use lighter materials – fiber reinforced plastics, thermoplastics, thermosetting plastics, organo sheet materials (continuous fiber-reinforced or fabric-reinforced thermoplastics) and metallic materials such as aluminum or magnesium – in combination with the latest production processes. This opens up the possibility of increased functional integration with advantages for the customer due to a reduced total number of parts. This saves not only on weight and materials, but also on development times and costs.

**INTELLIGENT LIGHTWEIGHTING
FROM ELRINGKLINGER**

- The benefits to you at a glance:
- + Reduced material use
 - + Greater cost-effectiveness
 - + Integration of numerous functions
 - + Functional testing of the entire module
 - + Better NVH characteristics
 - + Design freedom
 - + Shorter development times
 - + Reliable, easy assembly
 - + Recyclability
 - + Resource efficiency



DEVELOPMENT AND PRODUCTION COMPETENCE

ALL UNDER ONE ROOF.

From research and development through series production to just-in-time delivery of components ready for installation, our integrated approach generates synergies that pay off and help you move forward.

DEVELOPMENT AND PRODUCTION: THE COMPLETE SPECTRUM

- We have first-class facilities for product development, testing and production:
- State-of-the-art CAE tools for product design (static and dynamic structural mechanics plus acoustic analysis and optimization)
 - CFD flow simulation
 - Use of 3D CAD for tool-based component design in all standard CAD systems
 - Customer and part-specific functional and lifetime testing of components
 - Product testing in well-equipped application laboratories and on our own engine test benches

In this way we create customized plastic lightweight solutions for the drive train and car body. In doing so, we also set standards in product development and we are regarded as a leading technological system supplier by automobile manufacturers.

INVESTMENT IN THE FUTURE

ElringKlinger is also a major partner in publicly funded research and development projects of the Federal Ministries and the European Union.



**FROM THE IDEA THROUGH
TO THE SERIES PRODUCT**

**PRODUCT DEVELOPMENT/
MATERIALS COMPETENCE**

- Multi-material components (e.g. plastic, aluminum, organo sheet material)
- In-house material laboratories

**PROCESS DEVELOPMENT/
PRODUCTION PROCESSES**

- Plastic injection molding technology (JoinMelt, MuCell™)
- Hybrid technology
- Pressing and forming technology
- Connecting and joining technology

TOOL COMPETENCE

- In-house toolmaking for forming and injection molding tools
- Prototype and series tools

PRODUCTION COMPETENCE

- From prototype construction (technical center) to series production
- From small to large series production
- From manual to fully automated production

SUSTAINABILITY

Megatrend
**renewable
raw materials**

Project

CELLUN
Development and processing of multifunctional, sustainable and robust fiber-reinforced composites based on cellulose

BATTERY

Battery housing, cell connectors, pressure equalizing units, Electric Drive Units, ...

Megatrend
electrification

Project

HighKo – Highly integrated rear section concept for BEV
Development of structural, functionally integrative polymer-metal hybrid components

COMPOSITES

Thermoplastic composite hybrid components, door module carriers, underbody shielding parts, ...

Megatrend
lightweight

Project

thermoPre Plus
Technology for the processing of load-path multi-material architectures for high-performance, lightweight structural components



ElringKlinger's comprehensive materials expertise is based not least on our decades of experience in plastics processing.

PROCESS AND TOOLING COMPETENCE

EXPERTISE DOWN TO THE FIBERS

Achieving complex geometries. Implementing technically challenging product solutions. The ElringKlinger competence center for mold and tool construction reflects our system expertise in the areas of plastics processing (injection molding tools, press tools) and processing of composite fiber materials. And it makes even complicated things easy for you.

360° SERVICES SPECTRUM

One-stop shop: product design, toolmaking and sampling, measurement and optimization with optical 3D measurement technology, including all necessary welding processes and assembly work.

360° TOOLS SPECTRUM

- Injection molds for production of plastic parts with a shot weight of 20 g to 120 kg
- Highly polished tools for glazing applications
- Core melting process
- Tools for processing organo sheet materials
- SMC and GMT press molds (hot pressing processes)
- Press tools
- GIT and WIT tools
- Hybrid tools for different material combinations
- 2-component tools

360° MATERIALS SPECTRUM

The optimal, application-specific choice of materials and exactly the right component design ensure maximum functionality, safety and service life. Even under extreme environmental and usage conditions.

GOOD TO KNOW

Whether it is oil pans, intake air pipes, cylinder-head cover modules for sports cars or plastic parts for use in battery operated vehicles, ElringKlinger has a unique production cell at its Lenningen site that can manufacture small series with maximum flexibility on the zero defects principle. This uses the latest camera technology and flexible robot systems. The system can be programmed for a wide range of components, including all plastics welding processes.

THERMOPLASTIC COMPOSITE HYBRID

THE NEW METAL IS MADE OF PLASTIC.

As strong and durable as metal. Fast and reproducible in production. Our product solutions made of continuous fiber-reinforced thermoplastics are used wherever weight must be saved in structural and energy-absorbing components.

REACHING THE OBJECTIVE – IN TWO PHASES

The thermoplastic composite material (organo sheet, tape) is pre-cut. Before the injection molding process, the component is heated in an oven and transferred into the injection molding tool. The component is fixed with the aid of protruding retaining pins and then formed. The injection molding process begins and functional elements are injected. Finally the tool is opened and the component is demolded.

ADVANTAGES OF THERMOPLASTIC COMPOSITE HYBRID TECHNOLOGY:

- + Short cycle times
- + Downstream welding and gluing processes possible
- + Various material combinations possible
(fabric, unidirectional fibers; carbon, glass, aramid or steel fibers; PA, PP, ABS or PC and other thermoplastics)

DOOR MODULE CARRIER



The door module carrier is mounted to the vehicle's door frame. Functional elements are attached to it such as the window winder and the locking system. In the manufacture of the door module carrier, extremely lightweight and extremely stable fiber composite materials – known as organo sheets – are formed and plastic elements for additional component functions are injected in a single process step.

ADVANTAGES:

- + Weight reduction
- + Better NVH characteristics
- + Improved mechanical properties

THERMOPLASTIC COMPOSITE HYBRID PROCESS

1. The composite material is heated in the oven

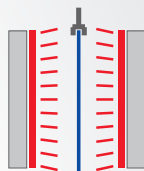

2. The composite material is transferred into the injection molding tool

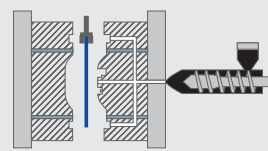

3. With protruding retaining pins or leading pins, the component is fixed in the injection molding tool

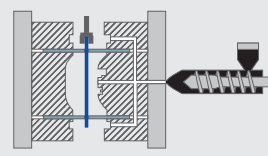

4. Handling is removed and the injection molding tool is closed

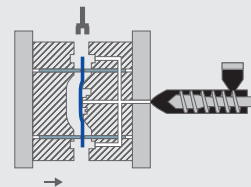

5. Forming of the thermoplastic composite material in the injection molding tool

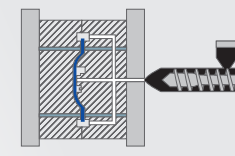

6. Plastic is injected

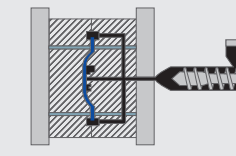

7. The injection molding tool is opened

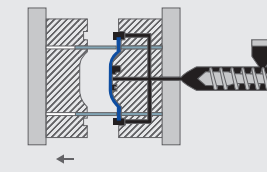

8. Component is demolded

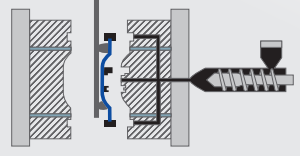

PRESSING AND FORMING TECHNOLOGY

LIGHTWEIGHT MATERIALS FOR HEAVY TASKS.

Efficient, quiet and light: by combining different composite materials, innovative components can be obtained for thermal and acoustic shielding and for use in areas with high strength, rigidity and durability requirements.

COST-EFFECTIVE AND WEIGHT-OPTIMIZED SOLUTIONS

Whether you require acoustic encapsulation or flow-optimized covering, underbody protection variants for off-road vehicles or for penetration protection for batteries, our material and process competence in pressing, forming and injection molding technology enables us to develop solutions for a wide range of requirements. New applications such as upper shells and covers for large underfloor storage systems for battery operated vehicles can thus be designed cost-effectively and with the optimal weight. The combinations of different materials used in the sandwich design offer advantages in particular with regard to crashes and bollard collisions. Thanks to its high strength, the thermoplastic material composite absorbs the energy flexibly and rebounds without leaving a permanent deformation in the form of a dent as with metal materials. This increases the robustness in everyday use and protects the battery system reliably from the next damage event in the same place.

CONTINUOUS FIBER-REINFORCED THERMOPLASTICS

Composite materials made from carbon or glass fibers, embedded in a thermoplastic matrix, such as organo sheets and unidirectional continuous fiber tapes (UD tapes).

ADVANTAGES:

- + High degree of strength and rigidity thanks to multilayer combinations of material with both low density and low wall thickness
- + High thermal and acoustic isolation
- + High damage tolerance

AREAS OF APPLICATION:

Plastic components with increased demands, for example underfloor shielding for battery- or hydrogen-operated vehicles.

ELROSAFE

Underbody shielding for battery systems

Innovative shielding solution for battery systems made from a thermoplastic material composite compared with conventional shieldings from aluminum.

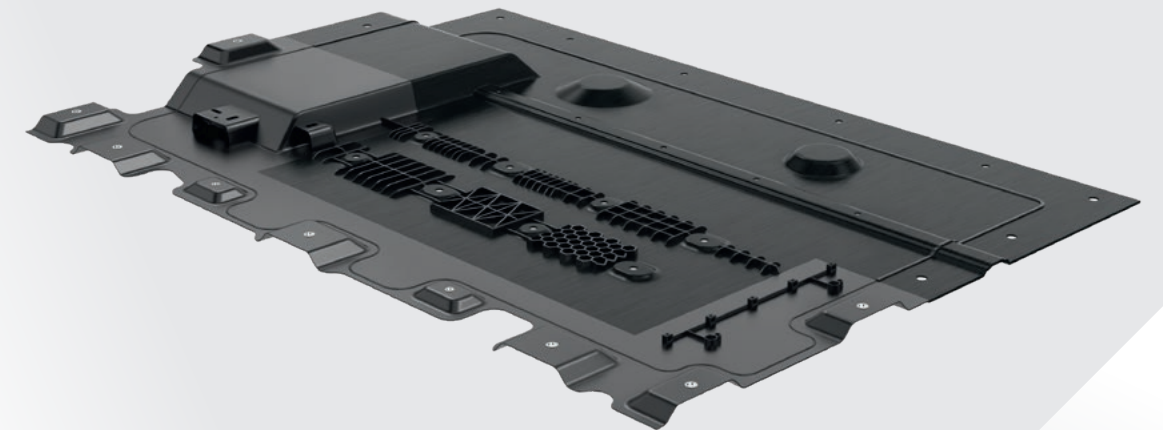
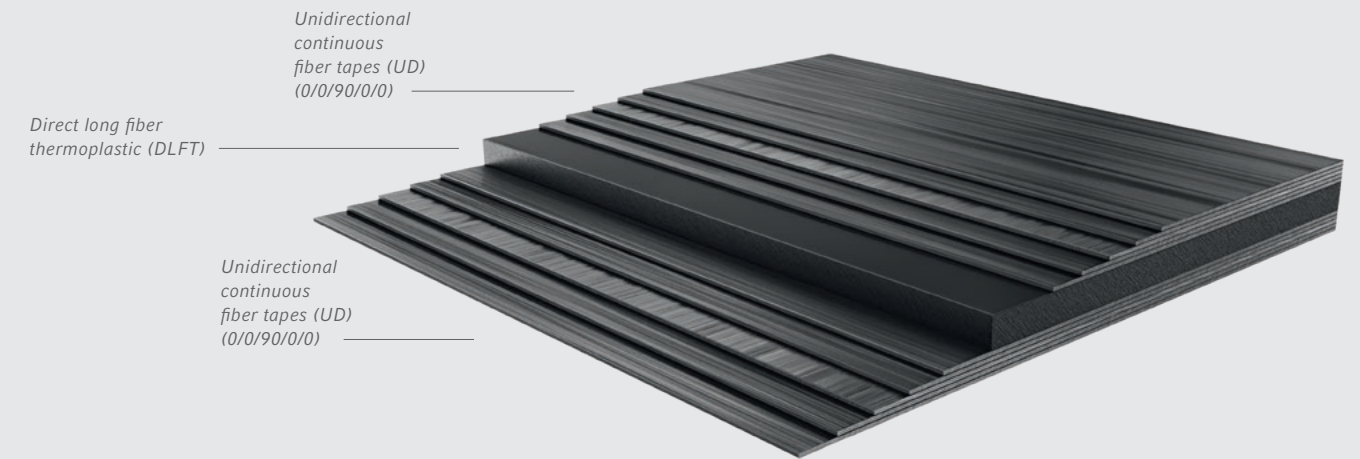



**LWRT
(LOW WEIGHT REINFORCED
THERMOPLASTICS)**

Composite material consisting of a thermoplastic, glass-fiber reinforced core, covered on both sides with acoustic fleece and/or aluminum foil.

ADVANTAGES:

- + Very good acoustic shielding properties at low specific weight
- + Water and oil-resistant, flame-retardant material
- + Satisfies different temperature requirements within the component
- + Additional aerodynamic functions can be integrated

AREAS OF APPLICATION:

Plastic components for special acoustic absorption and damping requirements, for example engine floors and underfloor areas, trunk covers and wheel arch liners.

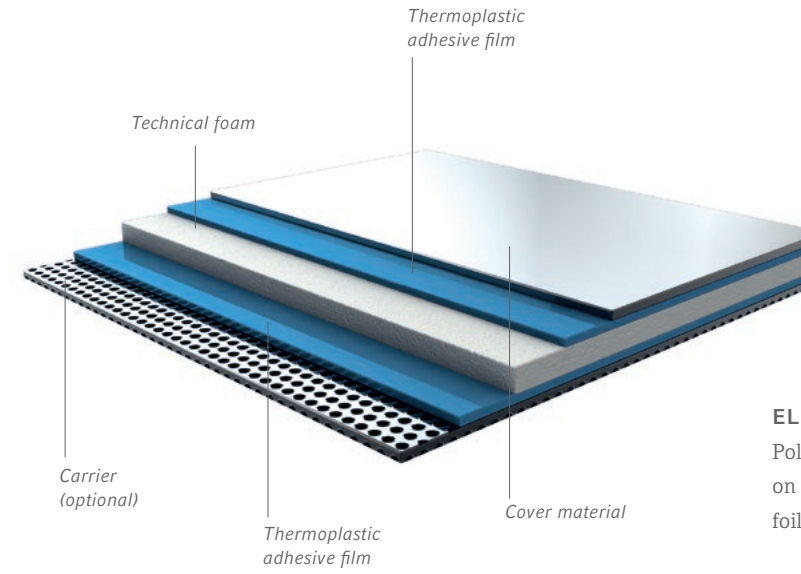

ELROCOUSTIC™ FOAMS

Polyester, polyurethane or duroplast systems covered on both sides with acoustic fleece and/or aluminum foil are normally used for foams.

ADVANTAGES:

- + Very good acoustic properties at low specific weight
- + High thermal and acoustic insulation
- + Water and oil-resistant, flame-retardant material
- + Good impact damping with very good elasticity

AREAS OF APPLICATION:

Acoustic absorption and damping components, for example for roof linings, interior side panels, engine compartments and replacement wheel arches.

**GMT (GLASS MAT-REINFORCED
THERMOPLASTICS)**

Composite material consisting of a glass fiber mat and/or long glass fibers which are impregnated with thermoplastic.



ADVANTAGES:

- + Very good acoustic shielding properties at low specific weight
- + Creation of complex shapes with no further rework
- + Particularly suitable in combination with other thermoplastic materials for reinforcing specific parts of components
- + Water and oil-resistant, flame-retardant material
- + Satisfies different temperature requirements within the component
- + Additional aerodynamic functions can be integrated

AREAS OF APPLICATION:

Plastic components for special strength and crash behaviour requirements, for example in underfloor areas, engine compartments, front ends or vehicle backs.

ELROCOUSTIC™ NON-WOVEN

Composite material made of natural, mineral or fleece fibers, with or without matrix material.

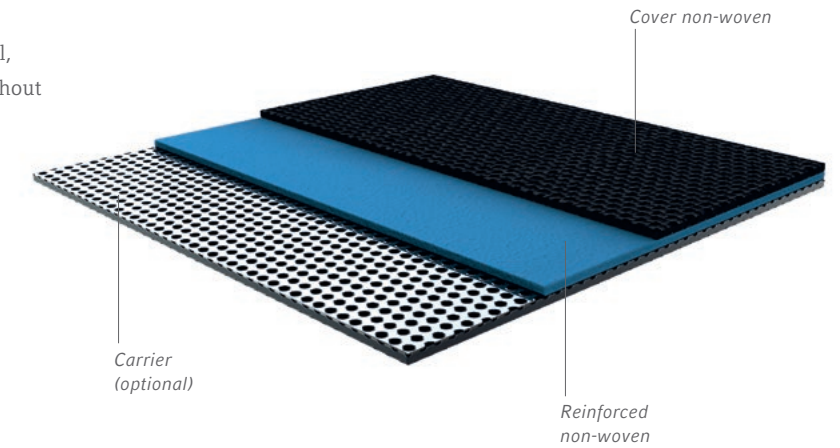

ADVANTAGES:

- + High noise reduction at close range to the noise source and also for environmental noises
- + No noise created itself, even with direct contact
- + High thermal and acoustic insulation
- + Low specific weight

AREAS OF APPLICATION:

Noise-damping components for e.g. engine insulation, engine encapsulation, underbodies, wheel arch liners and trunks.

PLASTIC-METAL HYBRID TECHNOLOGY

THE BEST OF BOTH WORLDS.

For the production of structural components, known as polymer metal hybrids (PMH), metal profiles are overmolded with thermoplastics and functionalized. One special form of this is the HFH process. Here, ElringKlinger uses a combination tool that brings together internal high-pressure forming of metal profiles and plastics injection molding in just one process step.

PLASTIC MEETS METAL

In the IHPF process, a thin-walled metal tube is inserted automatically into the mold. When the mold halves are closed, the tube is filled with a liquid and subjected to high pressure, which gives it its precise final shape. The highly integrated injection molding process (e.g. overmolding of metallic elements and other function elements or punching operations integrated in the injection tool) then begins in the same tool cavity. Here, thermoplastic is injected into the cavity to form the component contour. After cooling in the mold, the hybrid component is then removed automatically and finished in the subsequent processing steps.

INTERNAL HIGH-PRESSURE FORMING (IHPF)

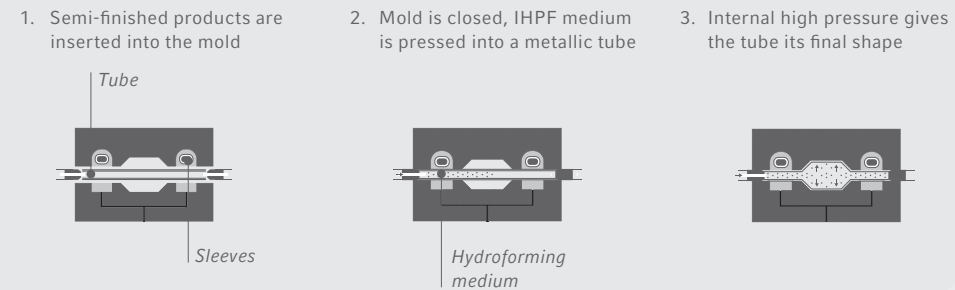

INJECTION MOLDING PROCESS

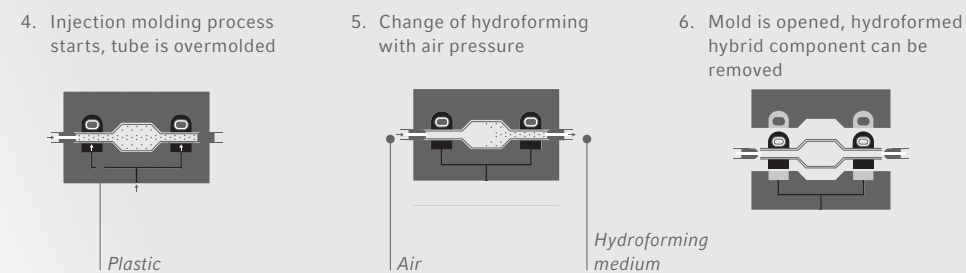

Cockpit cross-car beams from ElringKlinger combine maximum functionality with minimum weight. The support structure accommodates instrument panel, steering column, heating and ventilation modules, airbags, glove box, center console and other elements and connects them securely to the chassis.

ADVANTAGES:

- + Outstanding performance-to-weight ratio**
In comparison to existing technologies such as welded metal structures, HFH parts offer outstanding crash properties and high rigidity with low weight.
- + Load-path based design**
In addition, metal components made of magnesium, aluminum or steel sheet can be inserted in areas under heavy load.
- + Functional integration**
The plastic injection molding process facilitates very easy integration of additional functions, such as local fixing points.



ADVANTAGES OF HYDROFORM HYBRID TECHNOLOGY:

- + Short cycle times and high degree of automation
- + No rework required
- + High process stability and reproducibility
- + Global standards in the production of HFH parts
- + Many years of experience with HFH technology

Cockpit cross-car beam



Front-end carrier



Front-end adapter



CLASSICS WITH A FUTURE

Long established: our high-performance plastic components can withstand heavy mechanical loads and can be developed as ready-to-fit modules, including sealing and fixing elements.

A TRIED AND TESTED PROCESS, STILL IN DEMAND

When the tool is closed, the molten plastic is injected into the mold under high pressure. In order to compensate for volume shrinkage, holding pressure is applied to enable a material flow. Through the subsequent cooling process of the tool, the component becomes dimensionally stable. Finally the tool is opened and the component is removed.

Pressure equalizing units



Cylinder head covers



Ladder frames



Oil pans for commercial vehicles



Charge air components



ENGINE, GEARBOX AND POWER UNIT MOUNTS



As a specialist in plastic injection molding, ElringKlinger is also taking a step further with engine, transmission and power unit mounts, replacing the metal materials used previously with glass fiber-reinforced thermoplastics. Thanks to the use of glass fiber-reinforced polyamide, the components have significant advantages over traditional aluminum designs. The improved acoustics, greater heat insulation and weight advantage speak for themselves. Better heat protection, for example for the motor bearing, also increases service life.

ADVANTAGES:

- + Weight reduction
- + Multi functional integration
- + Potential cost savings
- + Better NVH characteristics
- + Less thermal conduction
- + Higher dimensional accuracy
- + High process stability and reproducibility
- + Decades of experience in thermoplastic processing, including for large parts with sealing functions

SEALING TECHNOLOGY USING ELASTOMERS

In addition to traditional plastic injection molding, ElringKlinger also offers various elastomer sealing solutions in conjunction with plastic components or as individual seals. Based on application-specific materials developed in-house, customized elastomer and metal-elastomer seals can be developed and manufactured for a wide range of possible uses. All elastomer materials are developed in our own material laboratories.

The latest tool and process technology allows cost-effective global production of the seals. These are already in use in electric drive units, gearboxes, combustion engines and in a wide range of high-pressure applications, and guarantee lifelong, reliable sealing of components from one another.

Further information and fact sheets about the individual products are available at www.elringklinger.com in the section entitled Products & Technologies.



ADVANTAGES:

- + Different material combinations to suit the application and the medium to be sealed
- + High tolerance balancing with simultaneous robust sealing compared to other sealing technologies

Housing gasket



Housing gasket for Electric Drive Units

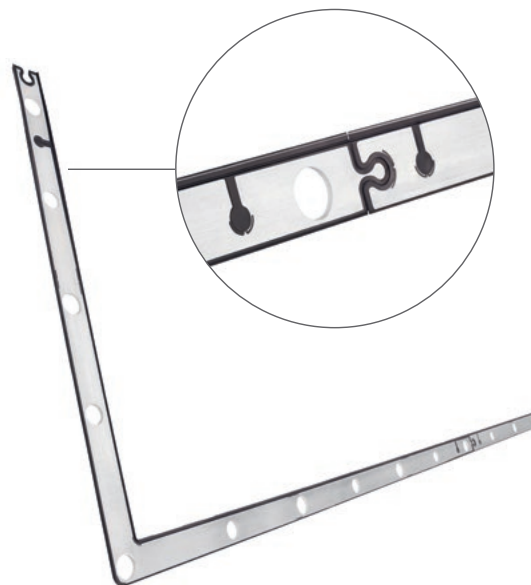

**PRODUCT EXAMPLE
METAL-ELASTOMER GASKET
IN PUZZLE DESIGN**

ElringKlinger offers an effective sealing solution for large flanges such as those on battery housings with its puzzle design gasket. The individual parts can be quickly and simply inserted into each other, with simultaneous pre-positioning using elastomer pins, so that they can be adapted to any geometry with rapid assembly and low space requirements.



**OUR PORTFOLIO.
FOR YOUR SUCCESS:**

- + Battery technology
- + Fuel cell technology
- + Electric drive units
- + E-mobility components
- + Lightweighting and elastomer technology
- + Sealing systems
- + Shielding systems
- + Components made of high-performance plastics
- + Dynamic precision parts
- + Tooling technology
- + Engine development services
- + Elring™ spare parts

ElringKlinger AG

Max-Eyth-Straße 2
72581 Dettingen/Erms
Germany
Phone +49 7123 724-0
E-mail info@elringklinger.com

www.elringklinger.com

The data provided here are the result of technological investigations. Such details are subject to change depending on the design of the system. We reserve the right to implement technical changes and improvements. The data are nonbinding and do not represent guaranteed characteristics. We accept no claims for compensation based on this information. We accept no liability for printing errors.